



金桥铝材集团有限公司

(& ,3C , , , ,)

(KAE, KLT)

(, , , , , , , ,)

(KAP)

KAP

KAP







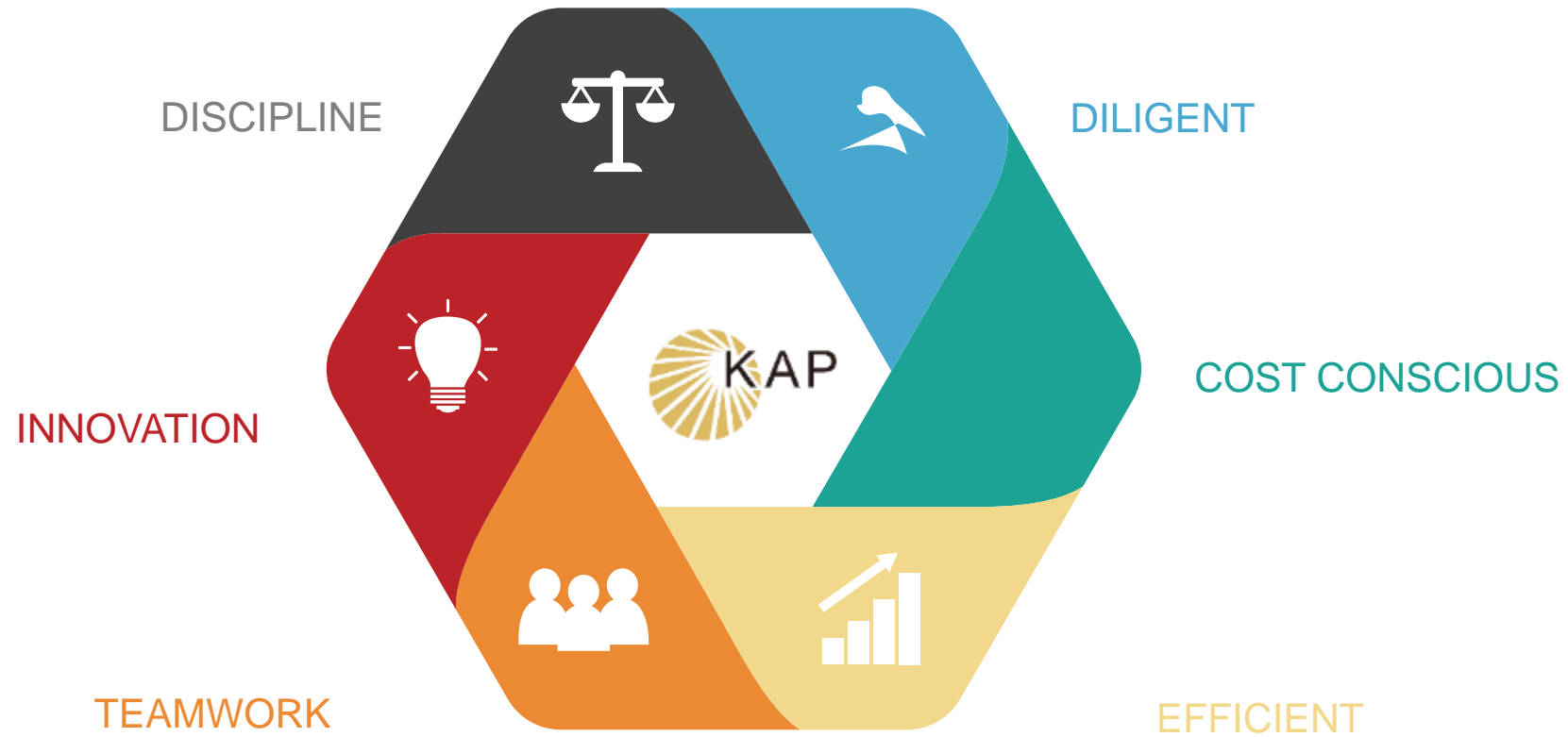

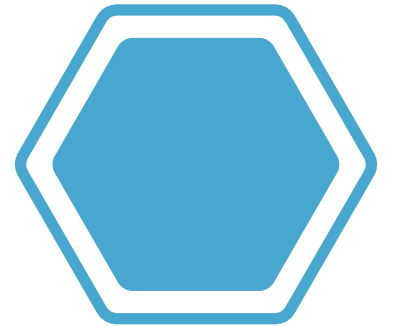
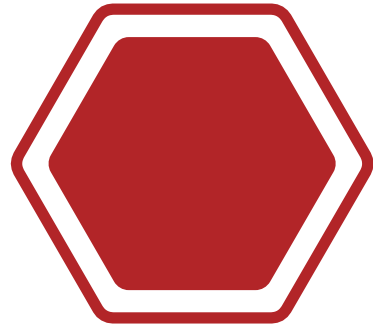
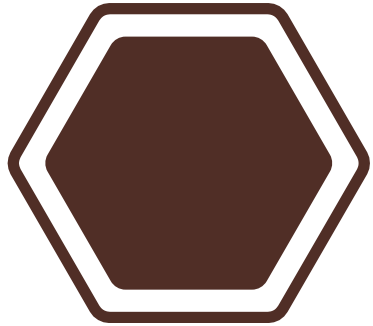

KAP

KAP



KAP

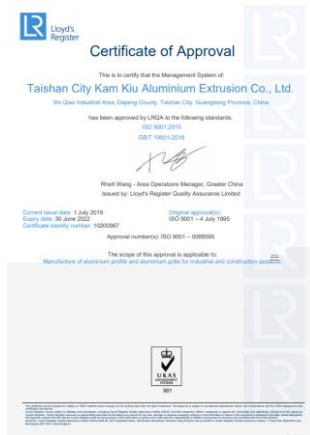

ISO 9001:2015



IATF 16949:2016



ISO 14001:2015
GB/T 24001:2016



ISO 45001:2018



DNV ABS GL BV
CCS

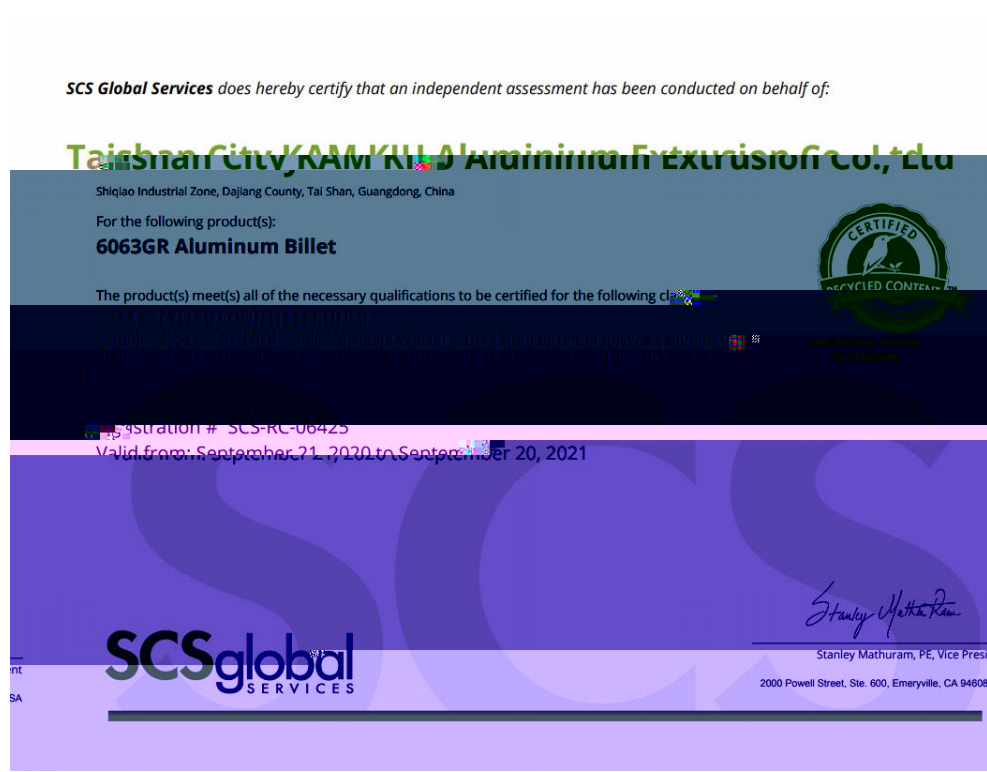

SCS

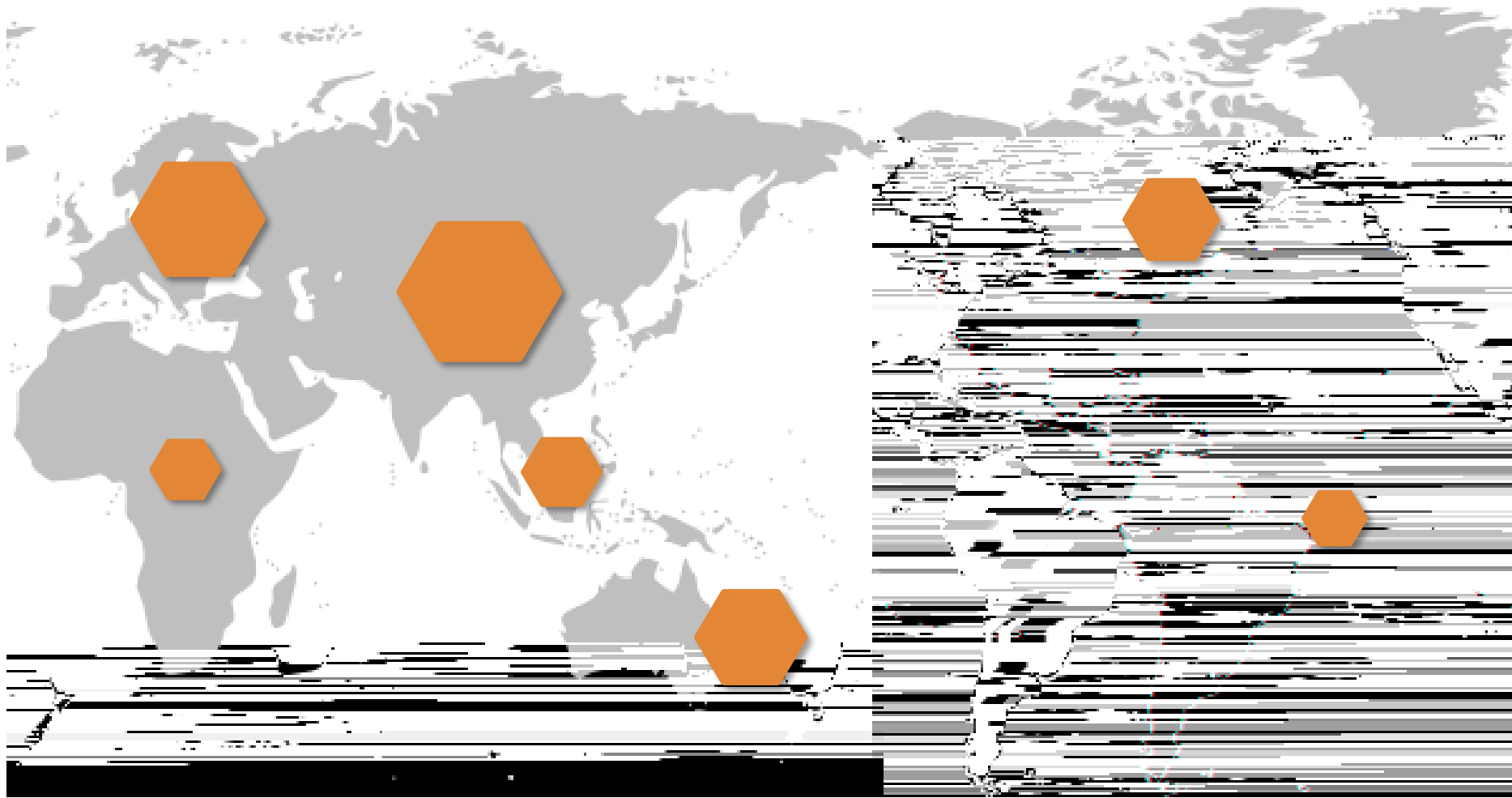

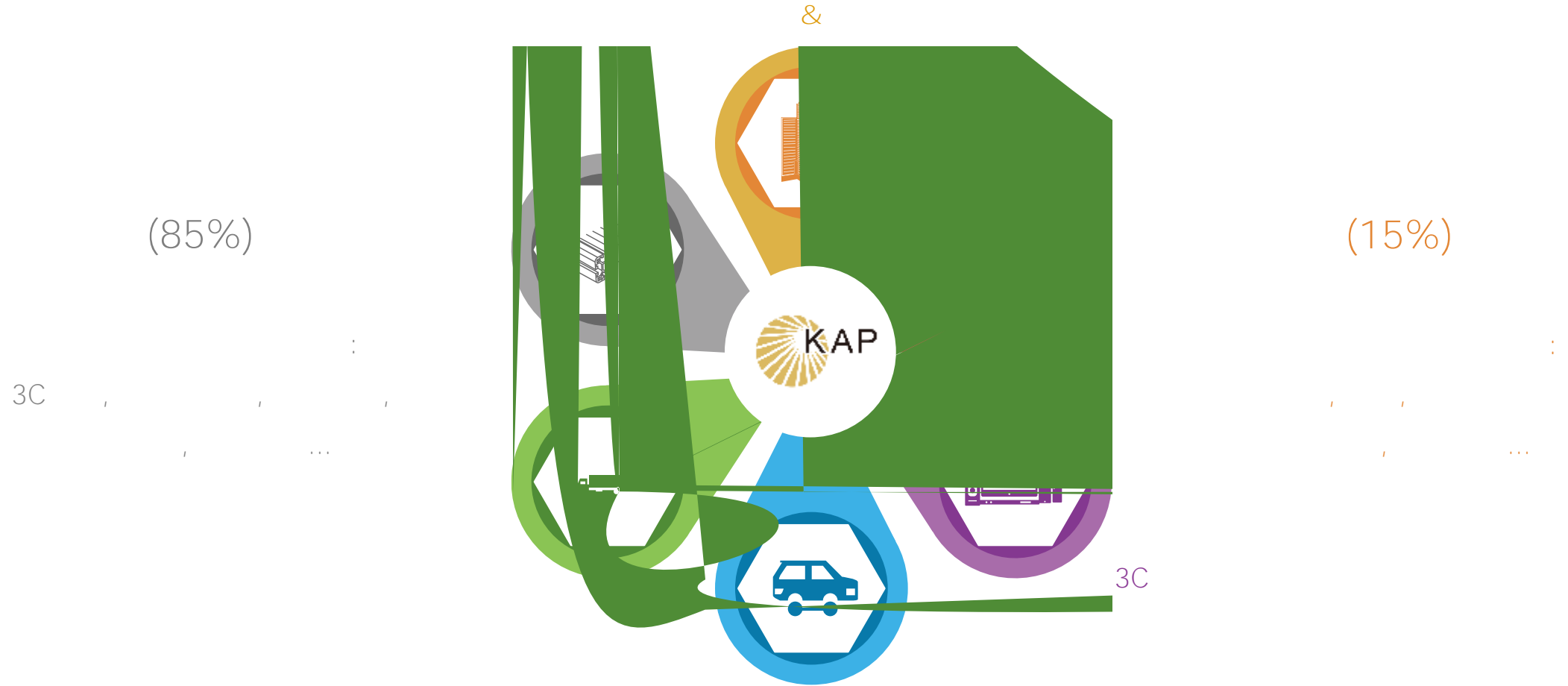

&

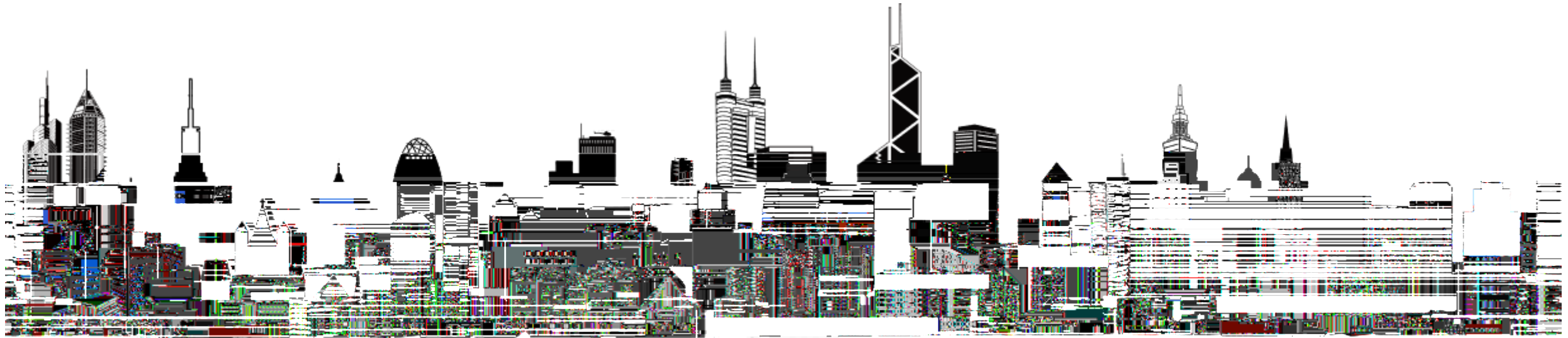

T R

UT

G K

3C



7XXX

70%



T R

UT

G K



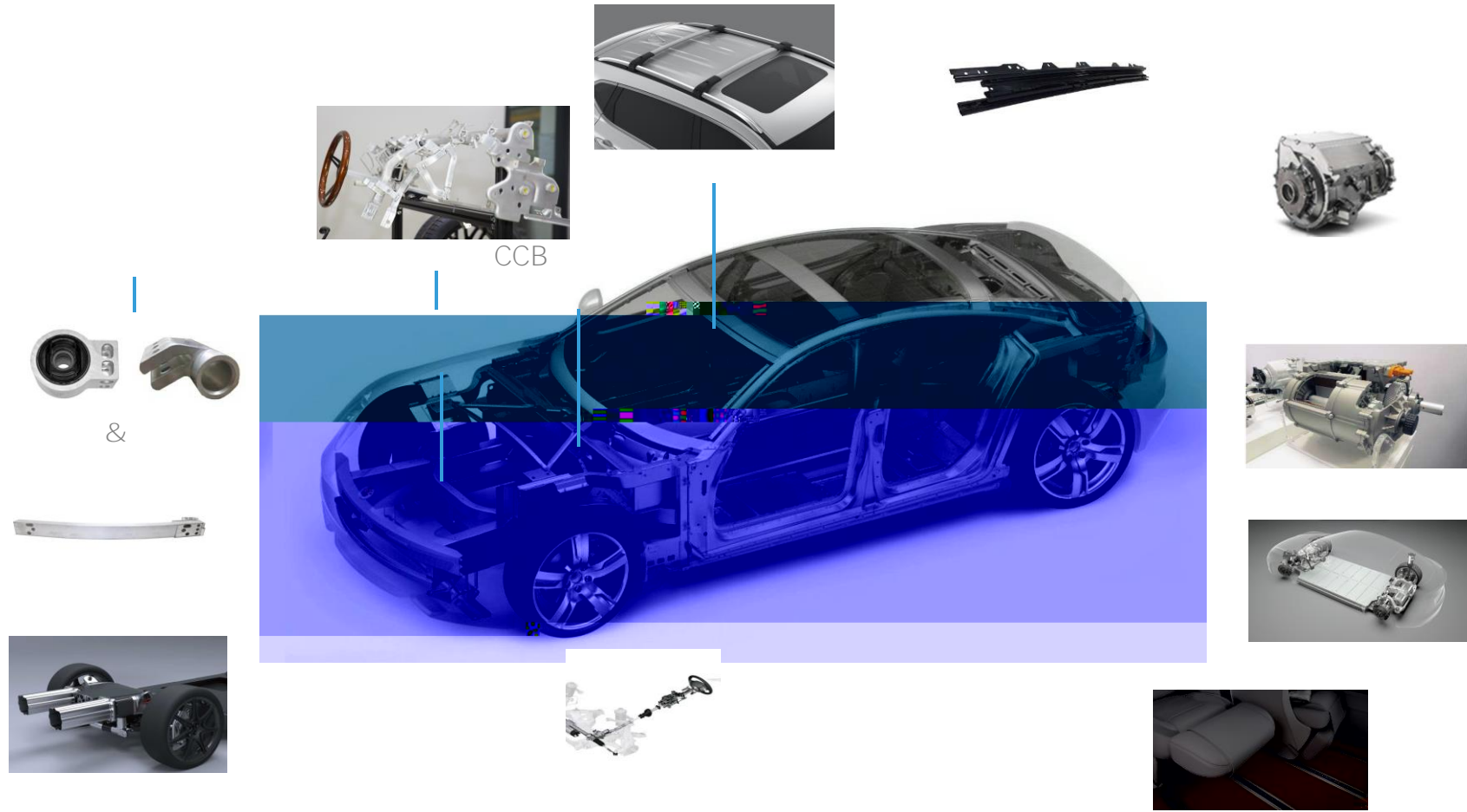

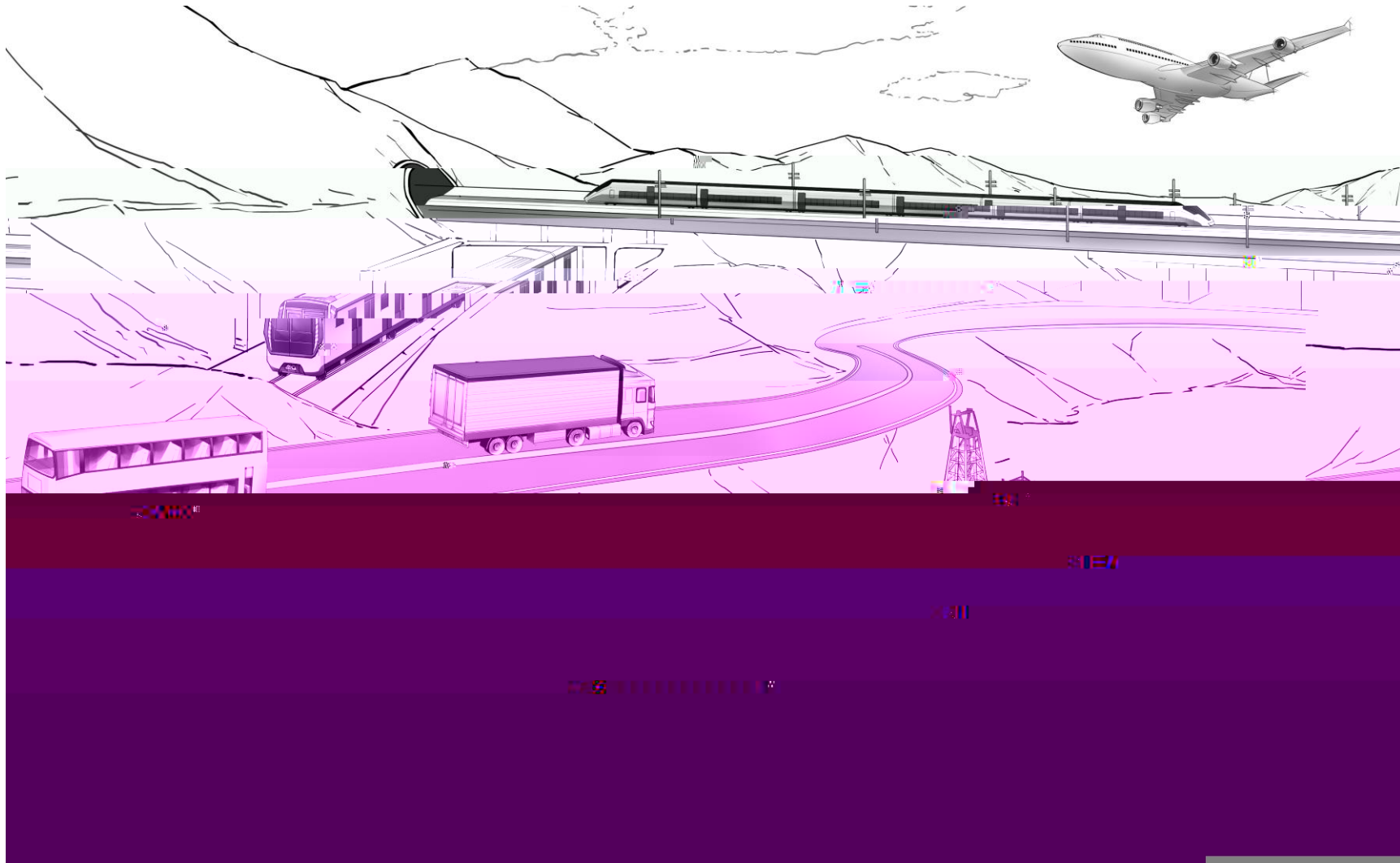

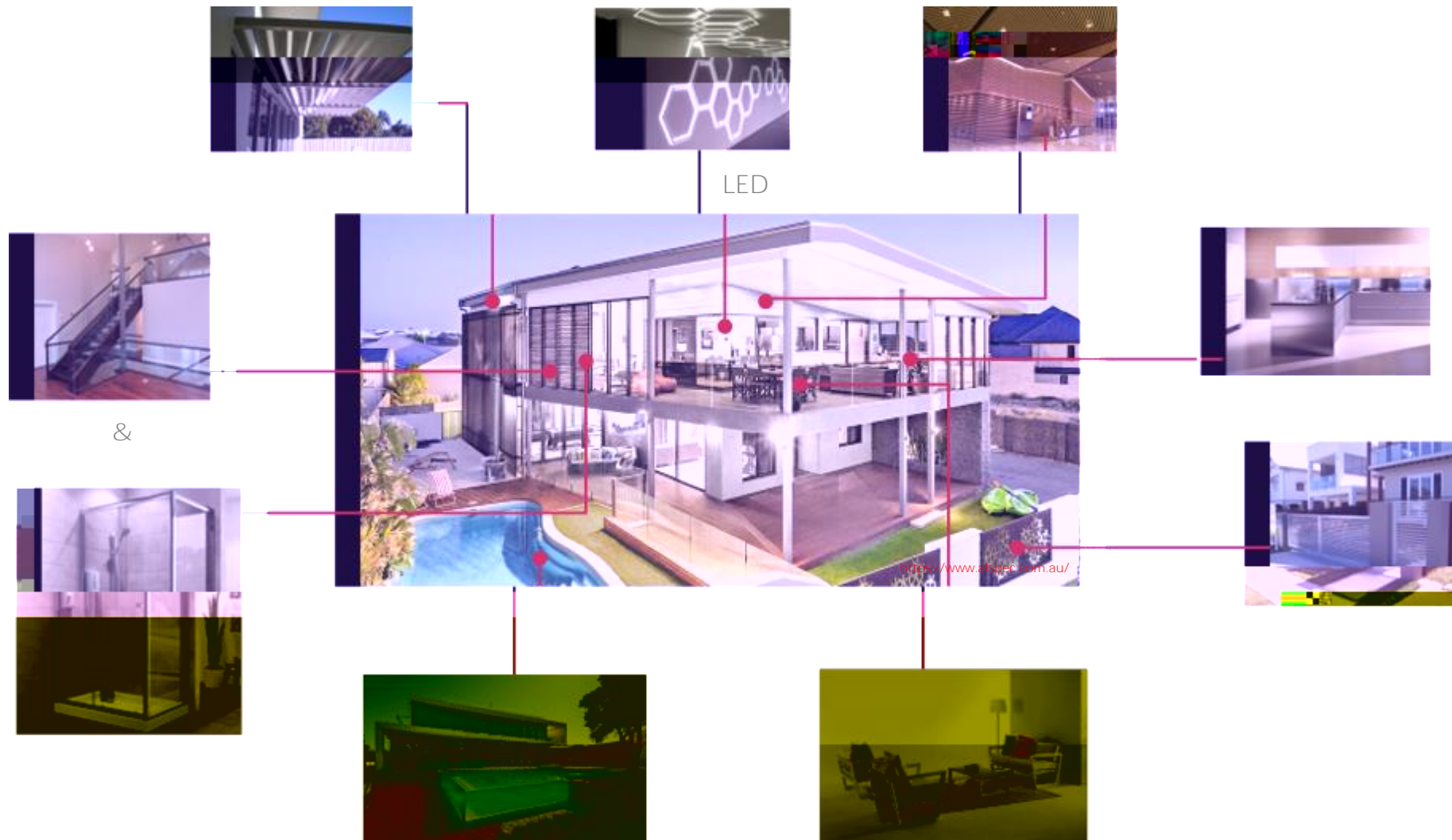

R T
T R

T R

UT

&

G K

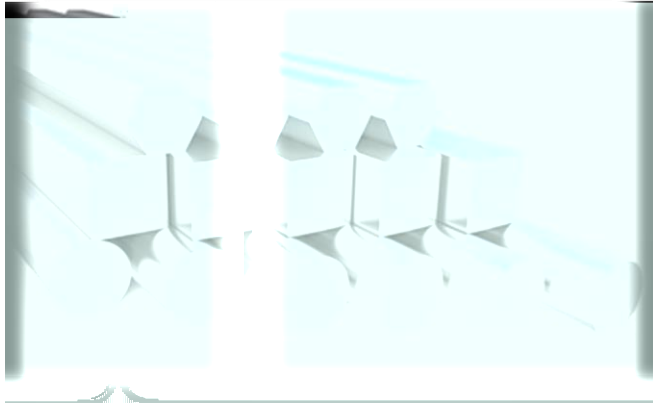

&

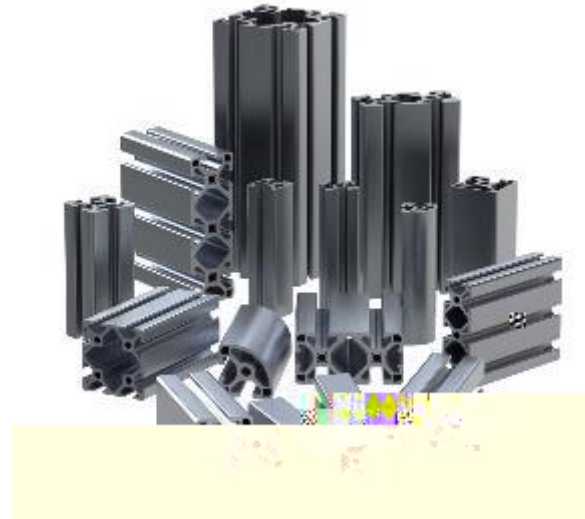
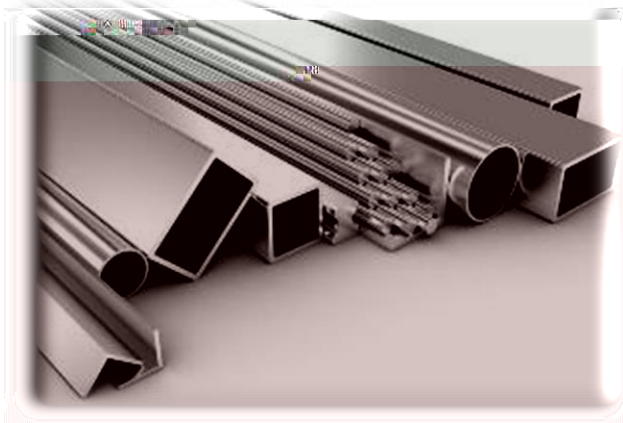

(KAE)

: 1983

: 389,000sqm.

: ~2500.



() (KLT)

: 2018

: 166,500sqm.

: 800 .

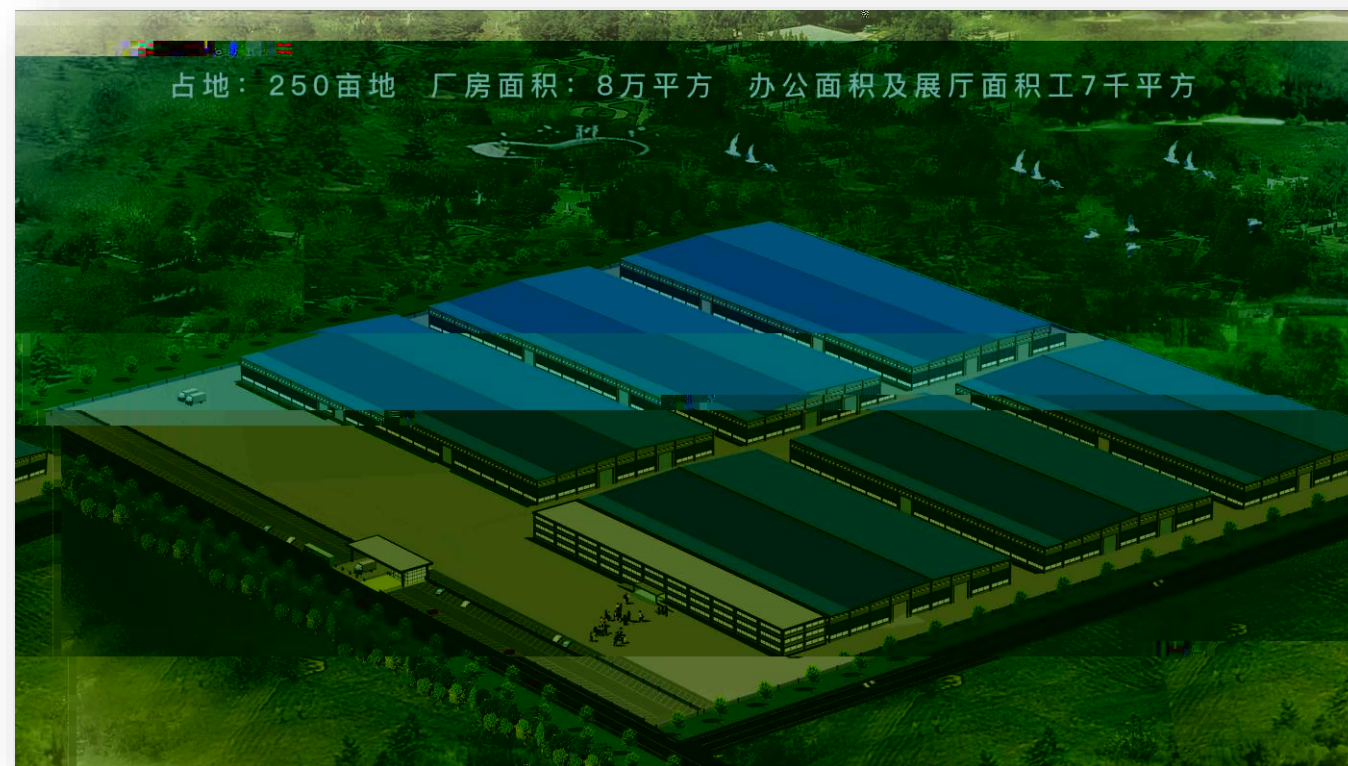

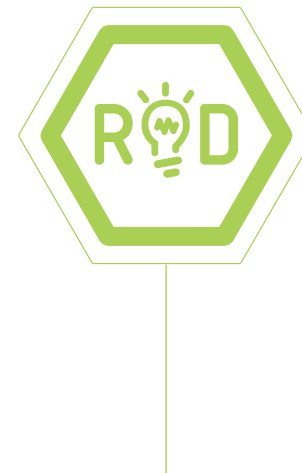
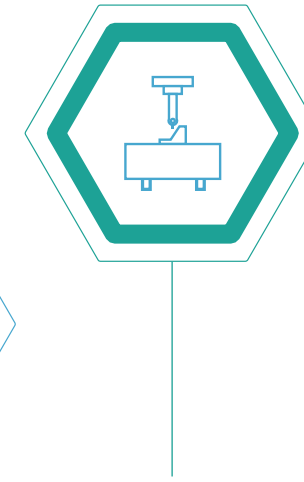
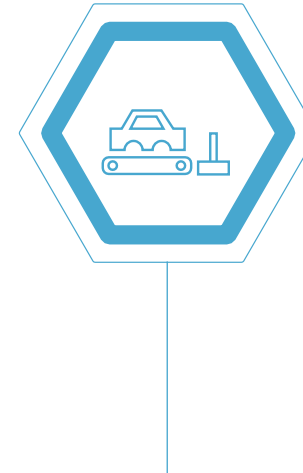
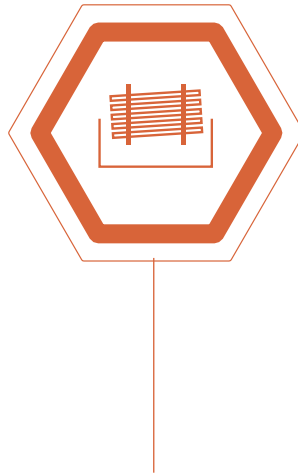
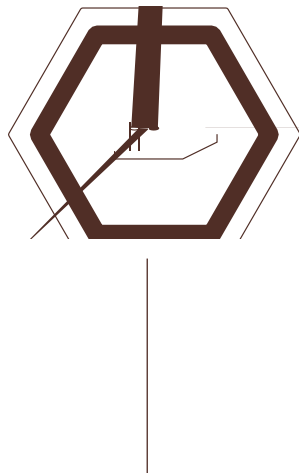
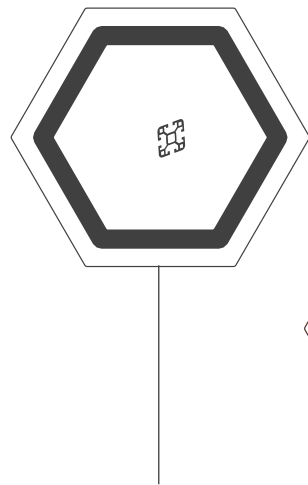

CNC



99.7%

1xxx, 2xxx, 3xxx, 5xxx, 6xxx, 7xxx

LNG,

16

	35	30	25	20
	1	4	9	2

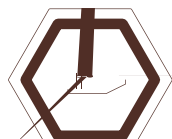

35

13

:

()	2800	1000
	2	2

:

()	6180	3680	2800	2500	1800	1250	1100	880	550
	2	1	5	6	3	1	4	5	4



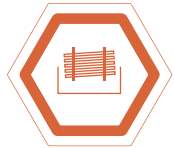
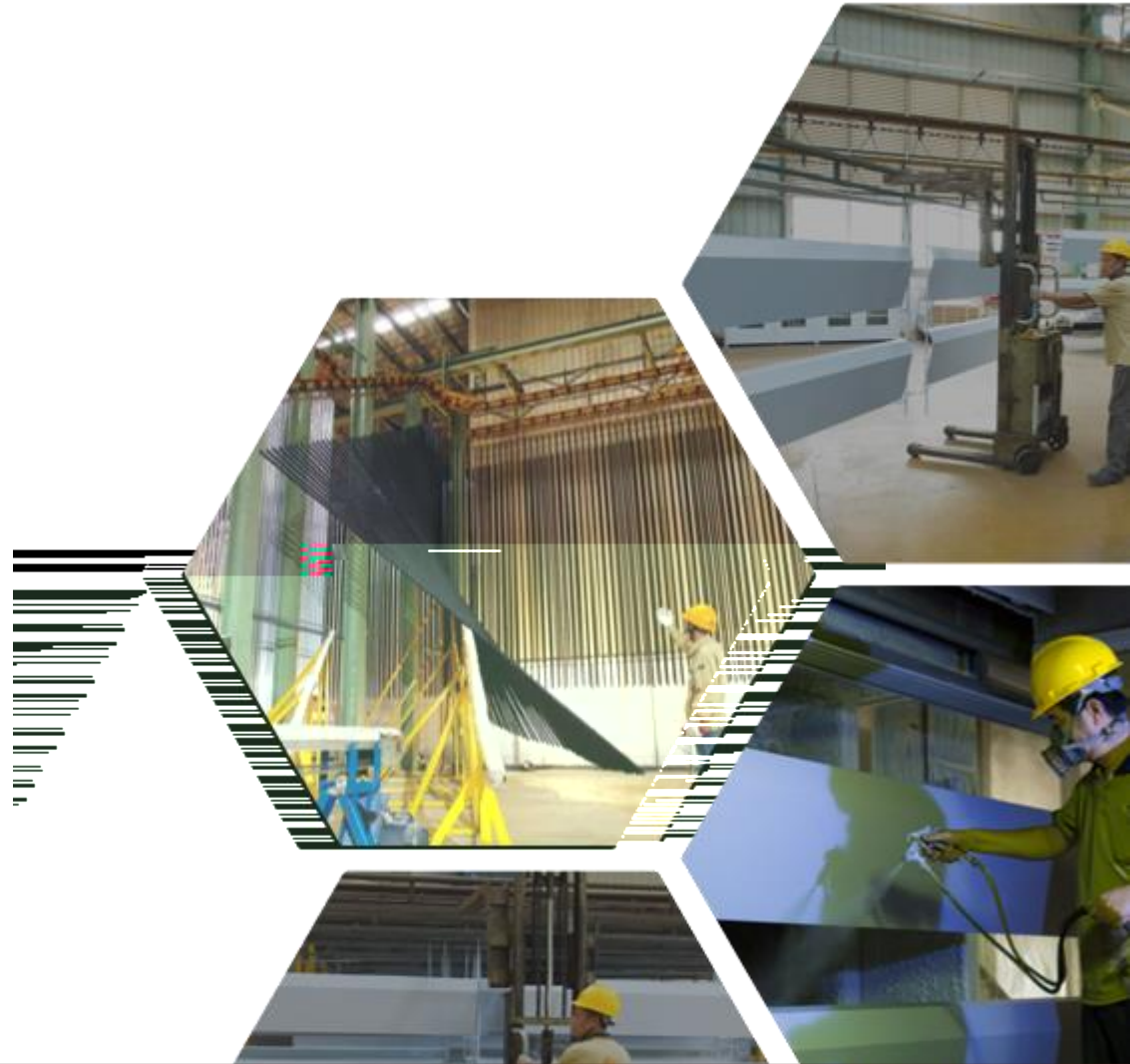

-
-
-
-
-

3 CNC

-
-
-
-
-

CNC



2017
<IATF16949>

SAP



:

-
-
-
-
-
-
-
-

- CMM

-
-
-
-
-

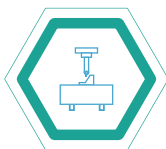

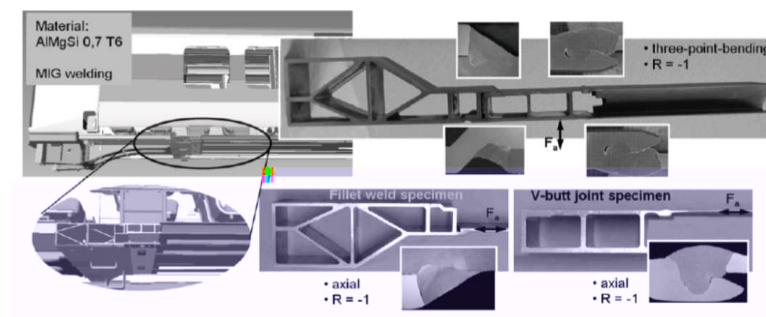
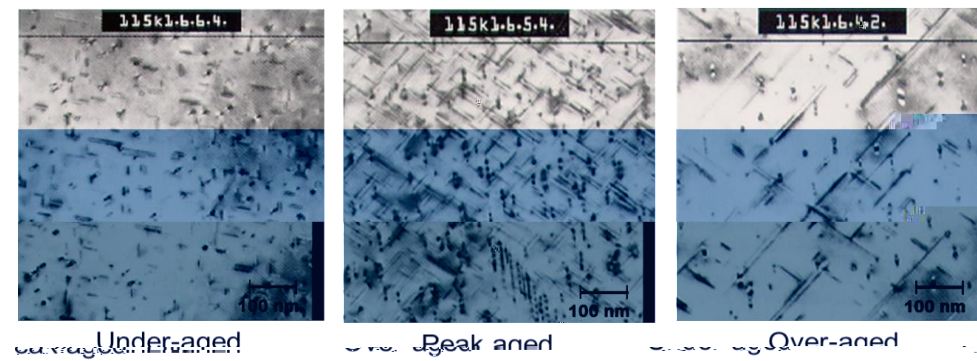

MIG\FSW



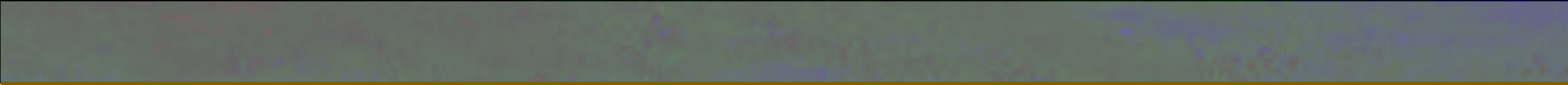

谢谢!